

Atenção: - Ao utilizar o cabo universal certifique que o mesmo esteja conectado corretamente no pino e sem mau contato.

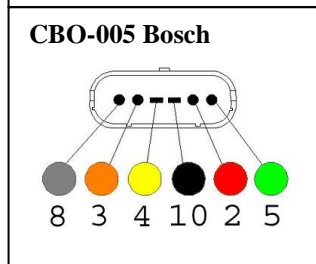

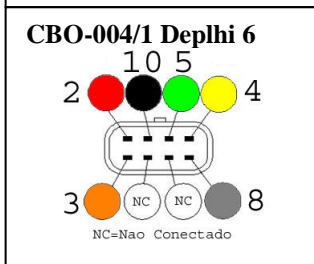
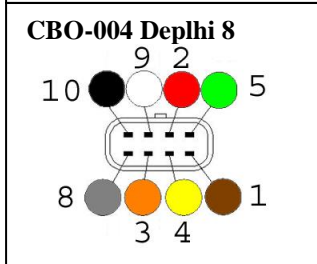
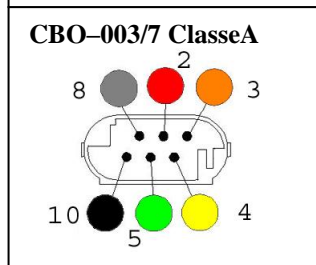
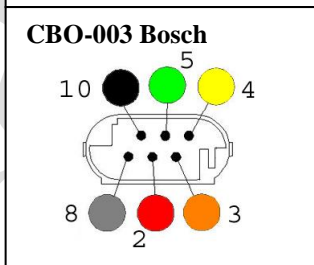
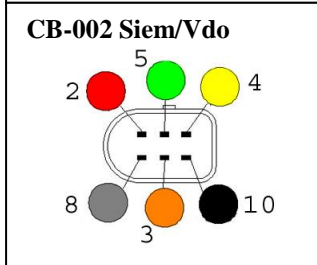
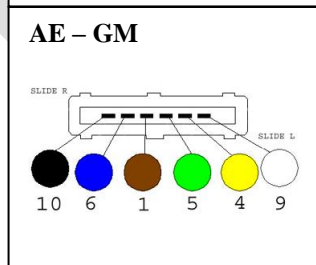
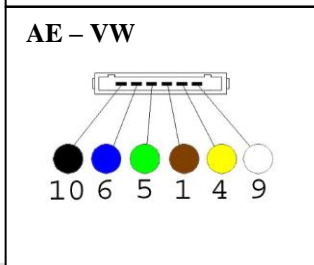
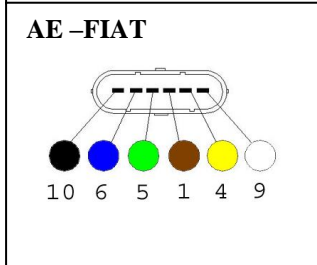
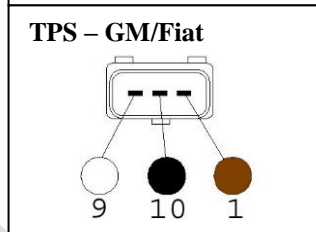
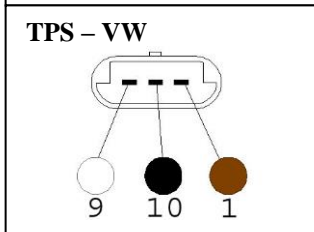
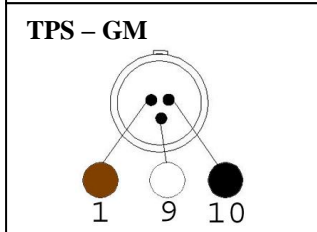
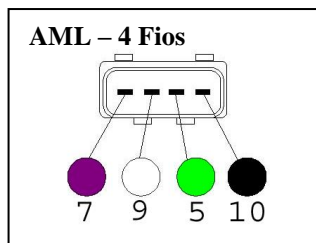
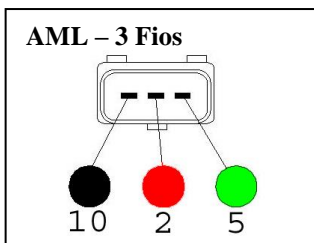
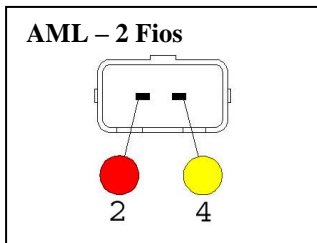
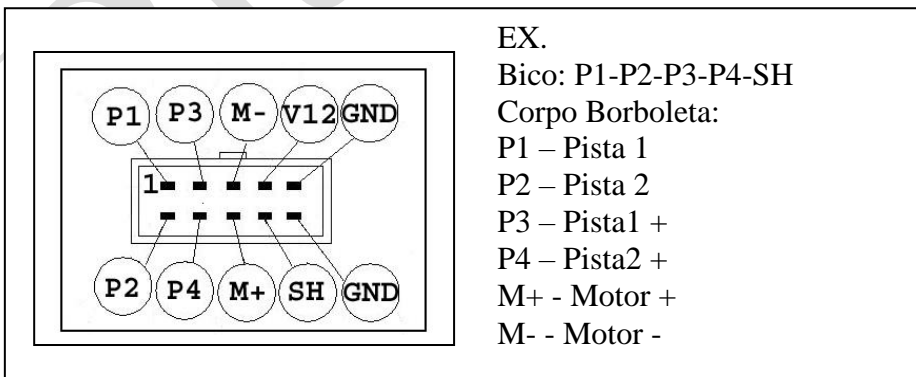
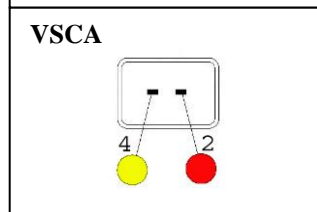
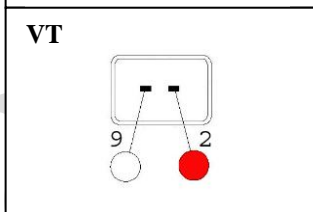
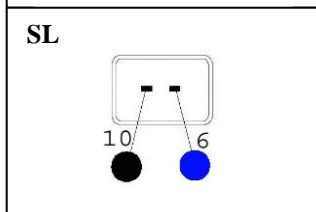
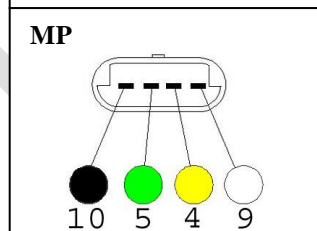
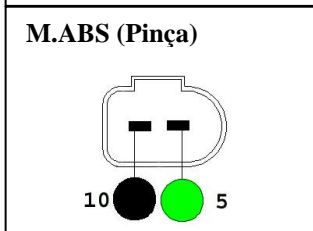
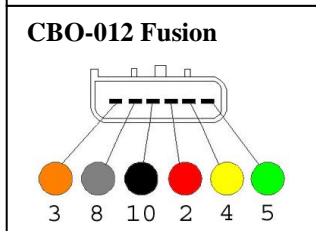
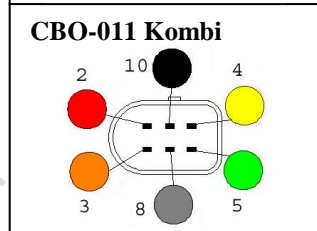
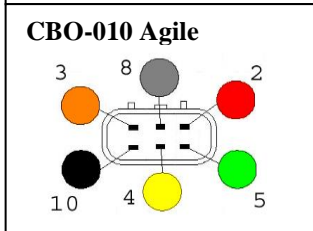
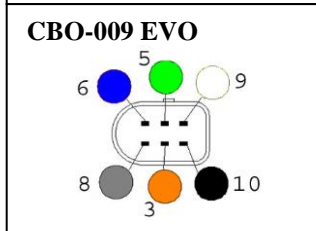
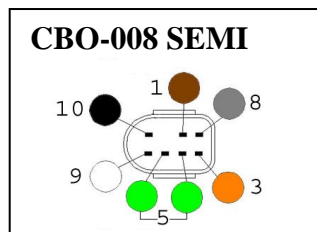
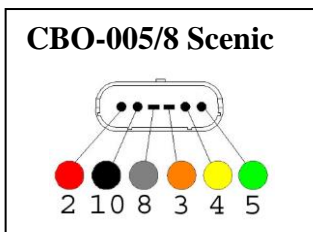
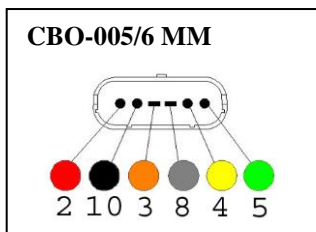

EX.

Bico: P1-P2-P3-P4-SH

Corpo Borboleta:

P1 – Pista 1

P2 – Pista 2

P3 – Pista1 +

P4 – Pista2 +

M+ - Motor +

M- - Motor -

Atenção: - Ao utilizar o cabo universal certifique que o mesmo esteja conectado corretamente no pino e sem mau contato.